

GNSS/SRO-100 GDK-2 Designer Kit

Patented Auto-Adaptive 1 ns Resolution

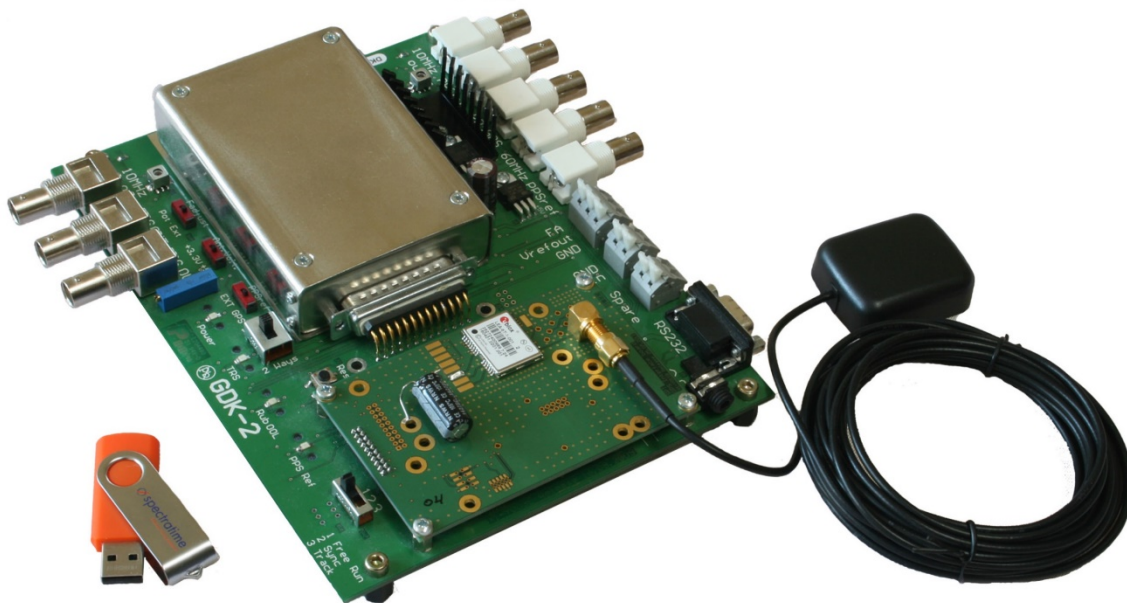

User Manual

Contents

1.	Board description	3
2.	Introduction	4
2.1	Designer Kit Serial Interface Diagram	4
3.	Supported GNSS Receivers	4
4.	System Requirements	4
5.	Installation Procedure.....	5
5.1	Safety!	5
5.2	Environmental Responsibility	5
5.3	System Installation.....	5
6.	Standalone SRO Master Oscillator.....	6
6.1	iSyncMgr Setup.....	6
6.2	Hardware Frequency Adjustment.....	6
6.3	Software Frequency Adjustment.....	6
6.4	PPSREF Frequency Comparison	7
7.	GNSS-Disciplined SRO Timing Clock	8
7.1	Introduction	8
7.2	Setup.....	8
8.	External PPS Disciplined SRO Timing Clock.....	8
8.1	Setup.....	9
9.	Tracking Mode	9
9.1	Tracking Mode Check	9
9.2	Loop Time Constant Tracking.....	10
9.3	Frequency Saving	10
9.4	Phase Deviations.....	11
9.5	PPS Ref Stability Requirement before Going in Tracking Mode.....	12
9.6	Frequency Jump when Going in Tracking	12
9.7	Tracking Restart.....	12
10.	PPS OUT delay	12
10.1	Free Run Mode	13
10.2	Tracking Mode.....	13
10.3	Sync Mode	13
11.	Module Customization	14
11.1	User Defined Message.....	14
11.2	GNSS Command Settings at Startup.....	14
12.	Updating the Firmware.....	15
13.	Supporting Documentation.....	15
	Mechanical Specifications	16

1. Board description

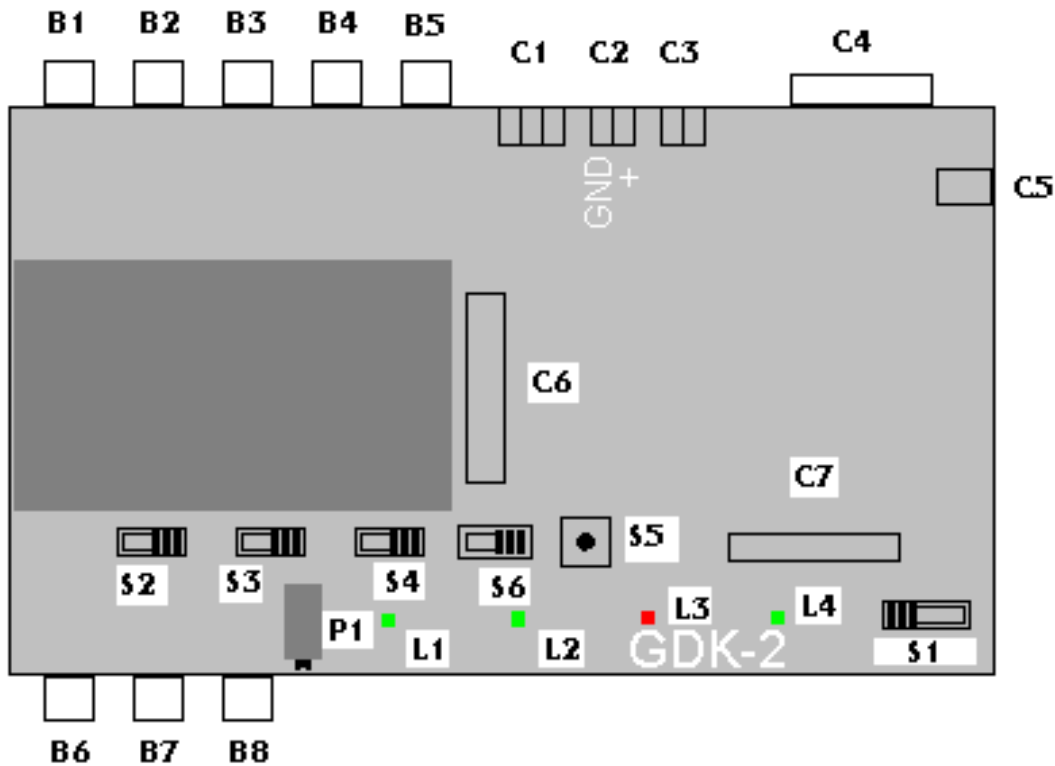

Figure 1

Tag	Description	Tag	Description
B1	10 MHz output, rear.	C1	External frequency adjust. FA: connected to pin 6 of the SRO. Vref out: connected to pin 7. GND: ground. In association with switch S2.
B2	PPS output, rear.	C2	Power supply. GND: ground. V+: 12 Volt or 24 Volt.
B3	PPS Ref output (GNSS), rear.	C3	Second power supply (do not use with SRO)
B4	60 MHz output.	C4	Serial RS232 interface.
B5	PPS Ref input.	C5	PPS Ref input. Power supply. Same as C2. For jack plug in.
B6	10MHz output, front.	C6	Connector for SRO.
B7	PPS output, front.	C7	GNSS interface.
B8	DDS output.	P1	Potentiometer for frequency tuning. In association with switch S2.
S1	Working mode selector. Pos.1: free run. Pos. 2: Sync. Pos.3: Track.	L1	Green Led, power supply ok.
S2	External frequency adjust source. Left: potentiometer P1. Right: external, connector C1. Default: Right.	L2	Green Led, tracking good.
S3	GNSS antenna voltage selector. Left: +3.3V. Right: +5V.	L3	Red Led, Rubidium line not locked.
S4	PPS reference selector. Right: on board GNSS receiver, if any. Left: External, B5.	L4	Green Led, PPS Ref tick.
S5	Reset switch		
S6	GNSS mode selector Left: 1 way Right: 2 ways		

2. Introduction

The designer kit allows users to rapidly interface an SRO with a GNSS receiver or an external 1PPS reference.

Through the RS232 serial interface, the user can communicate both with the SRO and supported GNSS receivers. The designer kit is ideally suited for developing a suite of timing applications based on the GNSS time distribution system.

2.1 Designer Kit Serial Interface Diagram

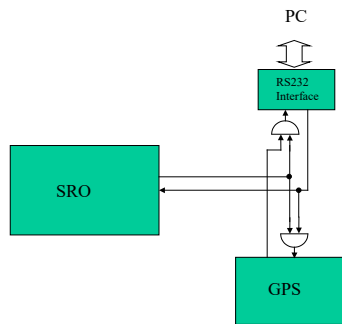

Figure 2 - Communication Diagram (Switch S6 to the left)

The PC listens to the SRO and the GNSS. The GNSS listens to the PC and SRO, but the SRO just listens to the PC. In this situation, Switch S6 to the left, the PC can communicate with both the GNSS and the SRO.

Communication with the SRO only:

Switch S6 to the right.

Communication with the GNSS only:

Take SRO away and Switch S6 to the left

3. Supported GNSS Receivers

Currently, 2019, only the u-Blox LEA-xT is supported. Regarding the Antenna, see App Note “GPS Antenna Installation Guidelines & Specs”

4. System Requirements

- A PC with:
 - Any Windows from XP to 10
 - A free serial port (RS232, 9 pin Sub-D)
 - An SRO-100.
- A 24V/2A or 12V/3A properly filtered power supply and power cable with 2 wires of different colors.
- A serial cable with 9 pin Sub-D connectors. One connector male, the other female.
 - Pin 2 connected to pin 2.
 - Pin 3 connected to pin 3.
 - Pin 5 connected to pin 5.

5. Installation Procedure

5.1 Safety!

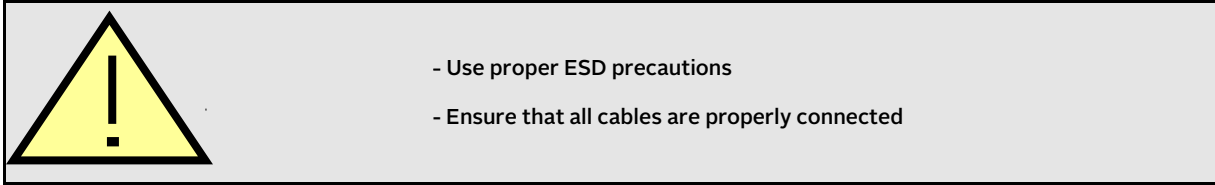

- Handling the product in a reasonably foreseeable conditions do not cause any risk for human health, exposure to the SVHC (substances of very high concern) would require grinding the component up.

5.2 Environmental Responsibility

- The equipment contains materials, which can be either re-used or recycled.
- Do not deposit the equipment as unsorted municipal waste. Leave it at an authorized local WEEE collection point or return to Orolia Switzerland SA to ensure proper disposal.
- To return the appliance:
 - Download and fill up the RMA form (from www.orolia.com/warranty-information/) and send it to clocksupport@orolia.com. We will contact you with shipment process details.

5.3 System Installation

- Connect the serial cable from the evaluation board to the PC.(C4)
- Mount an SRO on the evaluation board.(C6)
- Connect the evaluation board to the power supply.(C2)
- Connect the negative pole to "GND" and the positive pole to "+12".
- **!!! Be careful. The Evaluation Board is not protected against polarity inversion.**
- After 1s, the red LED on the Evaluation Board should light ON.(L3)
- That means the SRO is warming up.
- After maximum 10 minutes, the red LED should turn off, indicating the SRO is now centered on the Rb line.
- Put the CD Rom inside the reader.
- With Explorer, start the program iSyncMgr.exe.
- By default, the serial port is COM1.

If a warning popup window appears before the program iSyncMgr starts, it means COM1 is not free and another port has to be chosen. To do that, go to "Serial Port \ Port No" menu. Then choose another port.

Once the serial port problems are fixed, the button "Refresh" can be clicked. The Identification, Serial Number and Status of the SRO connected to the Evaluation Board should appear.

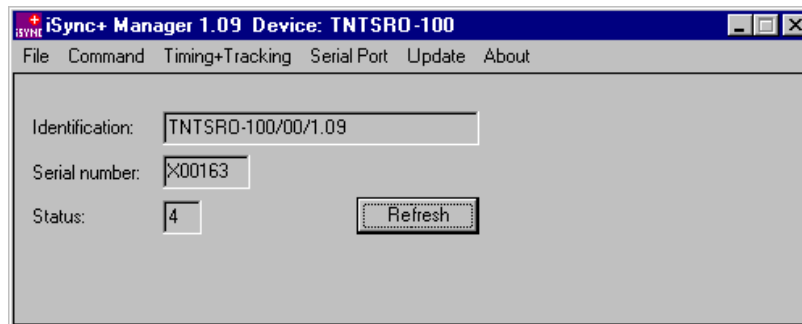

Figure 3 - iSyncMgr.exe Program

Now the Designer Kit is installed and is working properly. For easy communication, the iSyncMgr.exe application can be installed onto the user PC. This simple program is distributed freely. It doesn't write any code in the base register. It is recommended to check/download the last version of this software at www.spectratime.com.

6. Standalone SRO Master Oscillator

6.1 iSyncMgr Setup

- Click the Button “Refresh” from the main window.
- The Status should be 4 (Free Run).
- If not, go to the “Timing + Tracking” menu and choose “TRx”.
- In the “Track and Sync” dialog box, click the button “Don't track”.
- If there was an “X” on the left of the button “Track after Reset or Power On”, it should disappear.
- If the “X” remains, it means the switch (S1) on the designer kit is on 2 or 3. Put the switch (S1) on 1. The “X” should be gone.
- Leave the dialog box “Track and Sync” and click again on “Refresh”. Now the Status should be 4 (Free Run.)

6.2 Hardware Frequency Adjustment

In the SRO, the center frequency of the Rb line can be adjusted by changing the c field. With the designer kit, there are 3 ways to do that:

1. By applying a tension from 0 to 5 volts between “GND” and “FA”.(C1)
2. By connecting a potentiometer between “GND” and “Vrefout”.(C1) The middle point of the potentiometer should be connected to “FA”.
3. By activating the on-board potentiometer (P1) with the switch (S2); to the left.

In the 3 cases, the nominal frequency of the SRO will be modified. When not forced to another potential, the tension of “FA” is approximately 2.5 Volts.

Note: The SRO is factory tuned to 10.000'000'000 MHz. (Reference: GNSS). This tuning is only correct if pin 6 is let free, and not forced to a voltage.

6.3 Software Frequency Adjustment

In the case of a high-resolution frequency counter style HP, referenced by another 10 MHz master:

- Connect the “RF out” of the Evaluation Board to the counter. Make sure the counter is averaging to have enough digits. (at least 10 to 11 digits).
- From iSyncMgr, go to the “Timing + Tracking” menu and choose “FCsdddd”.
- For the correction, there is a simple rule:
- Take the value to be corrected in mHz (milliHertz) from the counter.
- Multiply by 100.
- Then subtract this value to the value in E-12 as read in the “Frequency correction” dialog box.
- Type the new value in the “E-12” field.
- Click on the buttons “<=Compute” and then “Store”:

The new frequency is now stored in the EEPROM of the SRO and, if the calculations were correct, the counter should indicate a value close to 10 MHz, tile the last mHz digit. (+/-1 digit)

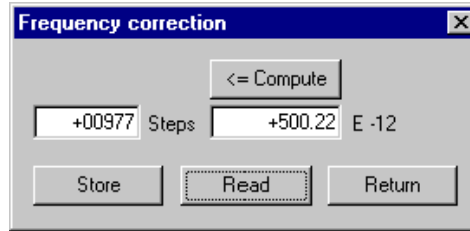

Figure 4 - Frequency Correction in Free Run Mode

6.4 PPSREF Frequency Comparison

In the case of a master sending out a PPS Ref:

- Connect this PPS Ref to the connector (B5) of the Evaluation Board.
- From iSyncMgr, go to the “Timing + Tracking” menu and choose “BTx”.
- In the Dialog Box “Beat something”, click on the “PPSINT vs PPSREF” button.
- The field below gives out the phase in 133 ns steps, between PPSINT and PPSREF.
- With the relationship: $\frac{\Delta f}{f} = -\frac{\Delta t}{t}$, we can find out the frequency difference between the two clocks.

Example: The phase increases 1 step every 33s.

We have:
$$\frac{\Delta f}{f} = -\frac{1 * 133 \text{ E} - 9}{33} = -4 \text{ E} - 9$$

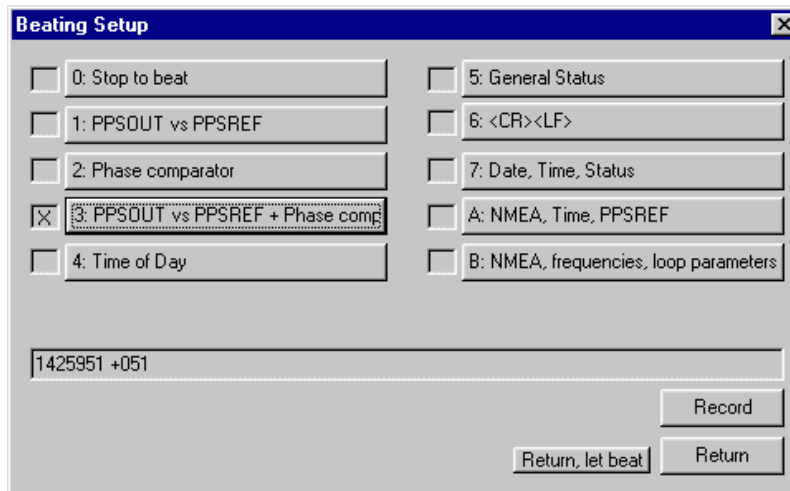

Figure 5 - Dialog Box “Beat Signal” Setup

Other schemes to measure the frequency difference can be set up. The phase evolution can be recorded for further computations with the “Stable32” application per example. To do this in the Dialog Box “Beat Signal”, click on the “Record” button. From now, the data coming out from the SRO are appended to the file “srolog.txt” as long

as the Dialog Box is opened. For simplicity, srolog.txt is located in the same directory as iSyncMgr.exe. If iSyncMgr.exe is on a CD Rom, no writing is done.

7. GNSS-Disciplined SRO Timing Clock

7.1 Introduction

The SRO is equipped with standard software able to track any PPS input reference signal with an auto adaptive filtering. (Please refer to the article wp_sro.pdf at www.orolia.com)

With this designer kit it is possible to validate a proven GNSS Disciplined (Rb) Oscillator configuration.

7.2 Setup

- Put a GNSS receiver on (C7).
- Choose GNSS as PPS Ref source by putting the switch (S4) to the right.
- The tracking can be initialized with the slide switch (S1). Position 1 or 2.
- It can also be initialized with iSyncMgr. To do so, go to the “Timing + Tracking” menu and choose “TRx”. Then click on the “Track now” button.
- If the SRO has to go immediately in tracking after Power ON and Warming Up, click on the button “Track after Reset or Power On”.
- After the tracking is set up, it takes a few minutes before the tracking becomes effective.

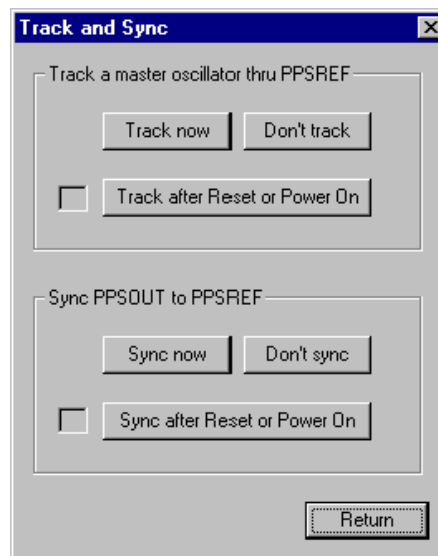

Figure 6 - “Track & Sync” Dialog Box

8. External PPS Disciplined SRO Timing Clock

The Evaluation board has a connector for an external PPS Ref.(B5)

8.1 Setup

- Connect the PPS Ref to track to the (B5) BNC connector of the Evaluation Board.
- To make the connector active, move the switch (S4) to the left.
- Then the procedure is the same as for the tracking of a GNSS PPS Ref., see Chap. 7.2

9. Tracking Mode

9.1 Tracking Mode Check

If the tracking to a PPSREF is successful, the green LED (L2) on the Evaluation Board will be lit.

- With iSyncMgr, it is possible to follow the evolution of the tracking. To do that, go to the “Timing + Tracking” menu and choose “ST”.
- As long as the tracking is set up, the Status is 1.
- Finally, the Status comes 2, “Track to PPSREF”.

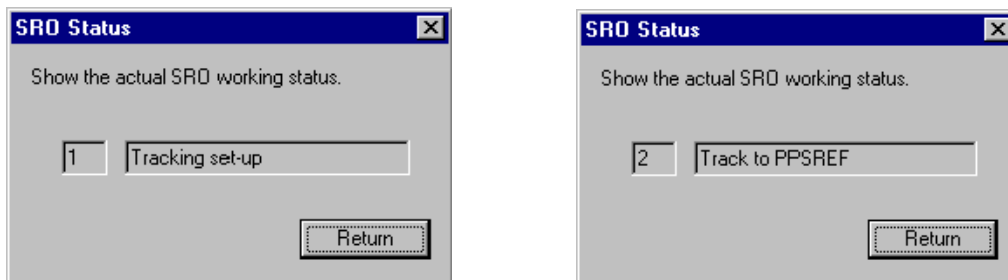

Figure 7a,b - Evolution Status After Tracking Setup

- The evolution of the tracking can also be followed more numerically. For that, go to the “Timing + Tracking” menu and choose “BTx”
- Clicking the button “PPSINT vs PPSREF” gives out the phase difference between the 2 PPS in 133 ns steps.
- Clicking on the button “Phase comparator” gives out the phase difference between the 2 PPS in approx. 1 ns steps. Please note that this value does not have any precision. It is just used to increase the resolution of the tracking loop.
- Clicking on the button “ PPSINT vs PPSREF + Phase comp.” gives out both values.
- As described before, see [Figure 5](#), these values can be continuously recorded by clicking on the button “Record”. The data coming out from the SRO are append to the file srolog.txt
- To see the frequency that the SRO is actually using to track a PPSREF, go to the “Timing + Tracking” menu and choose “FCsdddd”
- Each time the button “Read” is clicked, the frequency in use comes out.

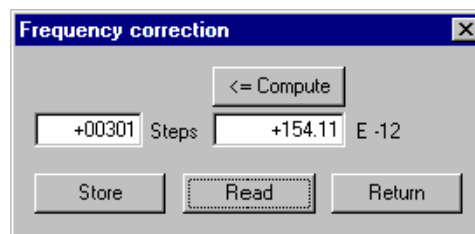

Figure 8 – Frequency in Use In Tracking Mode

9.2 Loop Time Constant Tracking

There are two working modes as follows:

- The tracking loop time constant can be set automatically by the SRO itself after analyzing the stability of the PPSREF, or it can be set by the user.
- Factory setting is the automatic mode. In this mode, the time constant can vary from 1000 s to 100'000 s.
- But the user can force a time constant from 1000 s to 999'999 s.
- To check the time constant mode in use, from iSyncMgr, go to the “Timing + Tracking” menu and choose “TCddddd”. The “Tracking loop time constant” dialog box gives out a value.
- If the value is 000000, it means the SRO is in automatic mode.
- A value between 1000 and 999999 means the time constant was forced by the user.

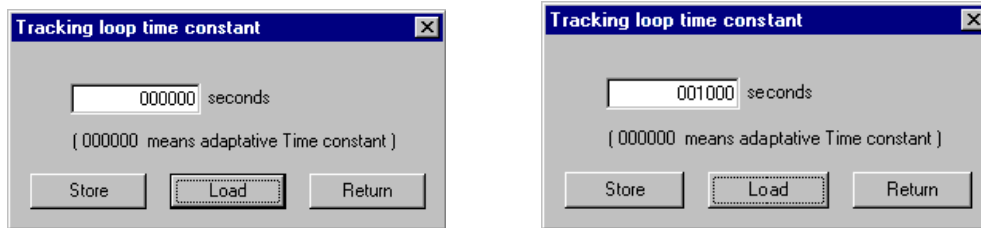

Figure 9a,b – Loop Time Constant Tracking in Auto & 1000s Manual Setting Mode

Normally the tracking loop time constant should be left in automatic mode. But it can be useful to put it to 1000 s to force the SRO to reach quickly the frequency of a master oscillator. Don't forget to put it back to automatic mode after it is done.

It is possible to check the stability of the PPS ref with the command VS and the time constant in use with the command VT. This is only possible in tracking, status 2 or 3. Please note that the value coming out with VS is averaged during hours.

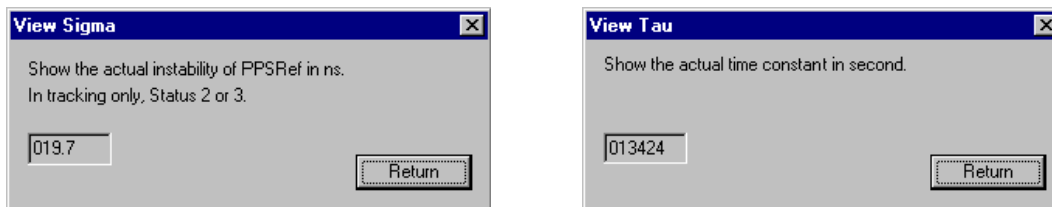

Figure 10a,b – Loop Time Constant “Tau” Values

9.3 Frequency Saving

When the SRO is tracking a PPSREF, the average frequency is saved every 24 hours in EEPROM. So, in case the SRO is powered off, it will restart with the right frequency.

But this way of working can be changed.

- From iSyncMgr, go to the “Timing + Tracking” menu and choose “FSx”. The “Frequency save mode” dialog box pops up. Normally a “X” should appear at the left of the button “Save average frequency in EEPROM every 24 hours”. That means the average value of the frequency is saved in EEPROM every 24 hours. But only if the tracking is successful. To avoid this saving, click on the button “Don't”.
- By clicking the button “Save integral part of freq. now”, the saving of that value is made.

- By clicking the button “Save actual frequency now”, it is not the integral part of the frequency that is saved, but the actual value.

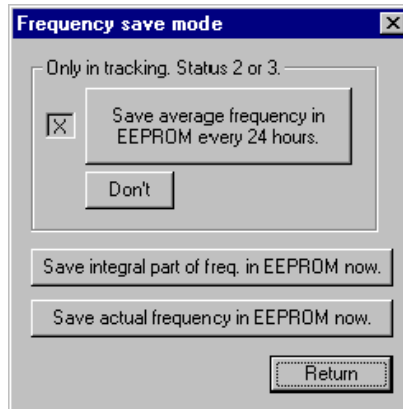

Figure 11 - Frequency Saving Mode

9.4 Phase Deviations

A regulation loop tries to reduce the error between a local input parameter and an external reference by changing an output parameter.

In the SRO, the error is the phase difference between PPSINT and PPSREF. The output parameter is the frequency. As the frequency should be as stable as possible, some input error is allowed.

The question is: What input error is acceptable? In the SRO, the answer was split in two: If the phase error goes out a first window, an alarm is raised up. In case the phase error goes out a second window, the tracking is stopped. It is so, as the SRO is supposed to track a Master at least as stable at itself.

To adjust these two windows from iSyncMgr, go to the “Timing + Tracking” menu and choose “TWddd”. The “Tracking and Alarm Window” dialog box pops up.

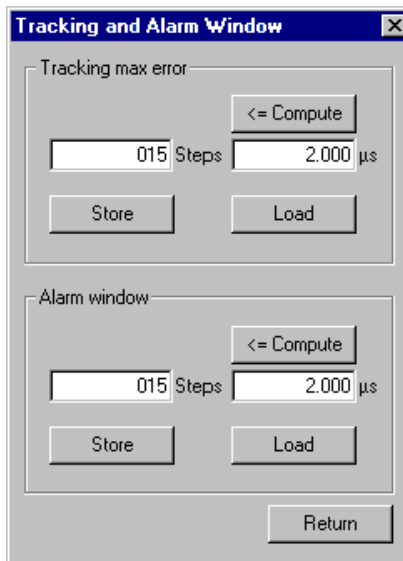

Figure 12 - Tracking and Alarm Window Dialog Box

9.5 PPS Ref Stability Requirement before Going in Tracking Mode

- The indication given here are only available for SW Vers. 1.09.
- Frequency offset between the master and the SRO:
- No test is done. To change this behavior, please contact our support department.
- PPS granularity of the master:
- A granularity of ± 133 ns is acceptable.

9.6 Frequency Jump when Going in Tracking

- The indication given here are only available for SW Vers. 1.09.
- The SRO doesn't make an initial frequency adjustment before going in tracking. To change this behavior, please contact our support department.

9.7 Tracking Restart

- The indication given here are only available for SW Vers. 1.09.
- The SRO is not able to restart a stacking tracking. To change this behavior, please contact our support department.
- ! This mean all precautions should be taken to avoid that the SRO receives a PPS Reference from a GNSS with no satellites in view during the tracking initialization.

10. PPS OUT delay

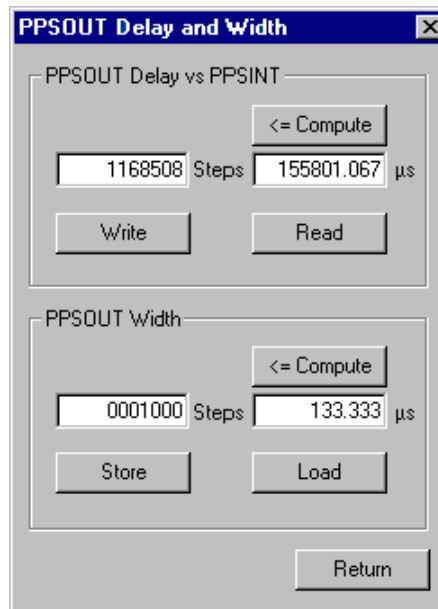

Figure 13 - PPS OUT Delay & Width Settings

10.1 Free Run Mode

It is possible to make some experiments with a PPSREF and a scope.

- Connect the PPSREF to the scope trigger and the PPS OUT of the Evaluation Board to a scope channel.
- Reset the SRO until the PPSOUT pulse of the SRO is visible with a time sweep not too slow.
- From iSyncMgr, go to the “Timing + Tracking” menu and choose “DEddddd”.
- Show on the scope how the PPS OUT pulse is moving when the delay is changed.
- In Free Run, the delay is referenced to itself.

10.2 Tracking Mode

- Connect the PPSREF to the Evaluation Board too. (B5)
- And set up a tracking. (TRx / “Track now”)
- Now, go to see what happens in the “PPSOUT delay and width” pop up dialog box. (DEddddd).
- The delay is 9999999 steps. It means that, during the tracking set-up, the delay is not defined and it cannot be changed.
- Wait until the Status comes 2 and check again the “PPSOUT delay and width” pop up dialog box. Now the delay is something between 0000000 and 7499999, and it can be changed.
- In Tracking, the delay is referenced to PPS REF when the tracking is perfect.

10.3 Sync Mode

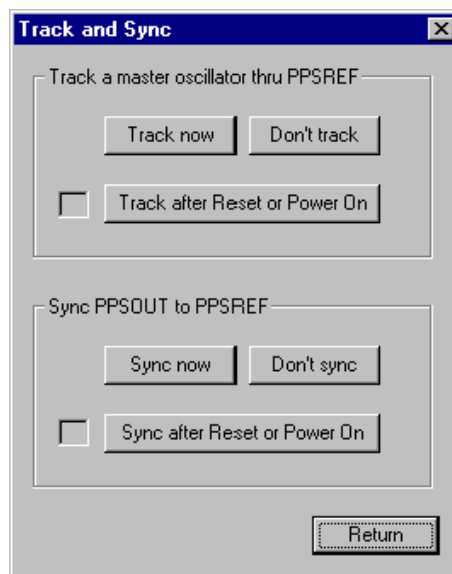

Figure 14 - Track & Sync Settings
(to synchronize PPS OUT to PPS REF, click on “Sync now”)

In sync mode the SRO don't just try to adjust it's frequency to the one of a master. But it also aligns its PPSOUT to the PPSREF of the master. Let's make a small experiment.

- Connect the PPSREF to the scope Trigger and to the Evaluation Board.
- Connect the PPS OUT of the Evaluation Board to a scope channel.
- Be sure the SRO is not set in Track or Sync mode by hard or by soft.

- Reset the SRO until the PPSOUT pulse of the SRO is visible with a time sweep not too slow.
- Remember the position of the PPS OUT pulse on the scope.
- Now , set up a tracking, with the switch (S1 position 3) on the Evaluation Board and wait until the green LED lights on.
- Observe that the PPS OUT pulse don't move. Now put the switch to Sync (S1 position 2).
- Immediately the PPS OUT pulse jumps to the left side of the scope screen, because the PPSOUT of the SRO is now aligned to the PPSREF.

11. Module Customization

The SRO can be customized. For that, go to "Timing + Tracking" and then click on "MCsdd".

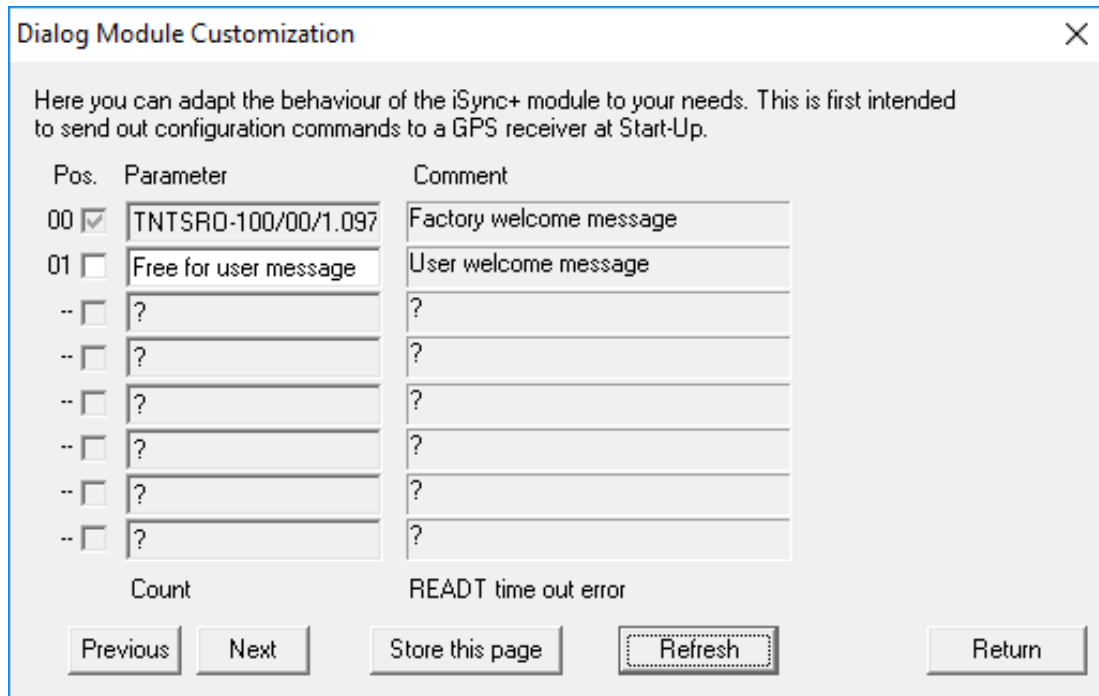

Figure 15 - Default Customization Settings

11.1 User Defined Message

The message \$00 is the identification of the SRO. It can be turned off and replaced by a user message stored in EEPROM, the message \$01.

11.2 GNSS Command Settings at Startup

Currently (2018), the only GNSS available is the u-Blox LEA-xT. In this receiver, the configuration is stored in eeprom and doesn't need a configuration at startup.

12. Updating the Firmware

With iSyncMgr.exe, it is possible to update the SRO to the last software revision.

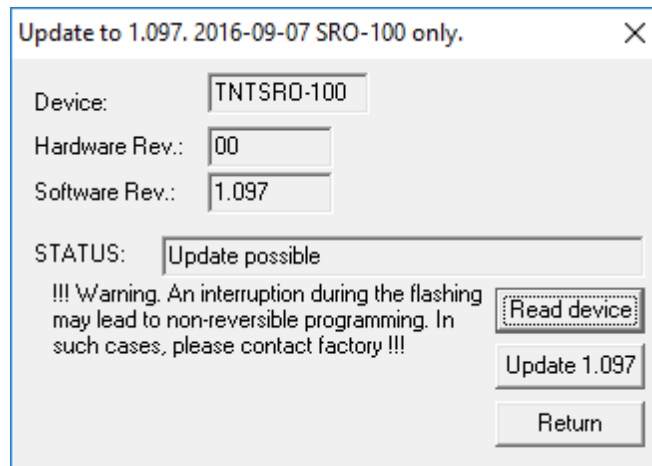

Figure 16 - SRO Update by Clicking on "Update 1.09"

Choose Update. The program will check the SRO. If the Update is possible, the STATUS on the dialog box will be "Update possible". Then click on "Update 1.xx".

WARNING : The process takes approximately 1 minute. If for any reason, like power down or defective serial cable, the process is aborted, then the SRO shall be sent back to factory.

13. Supporting Documentation

- www.orolia.com
- GNSS LEA-xT and GDK-2
- Playing with 2 GDK-2 Designer kits

Mechanical Specifications

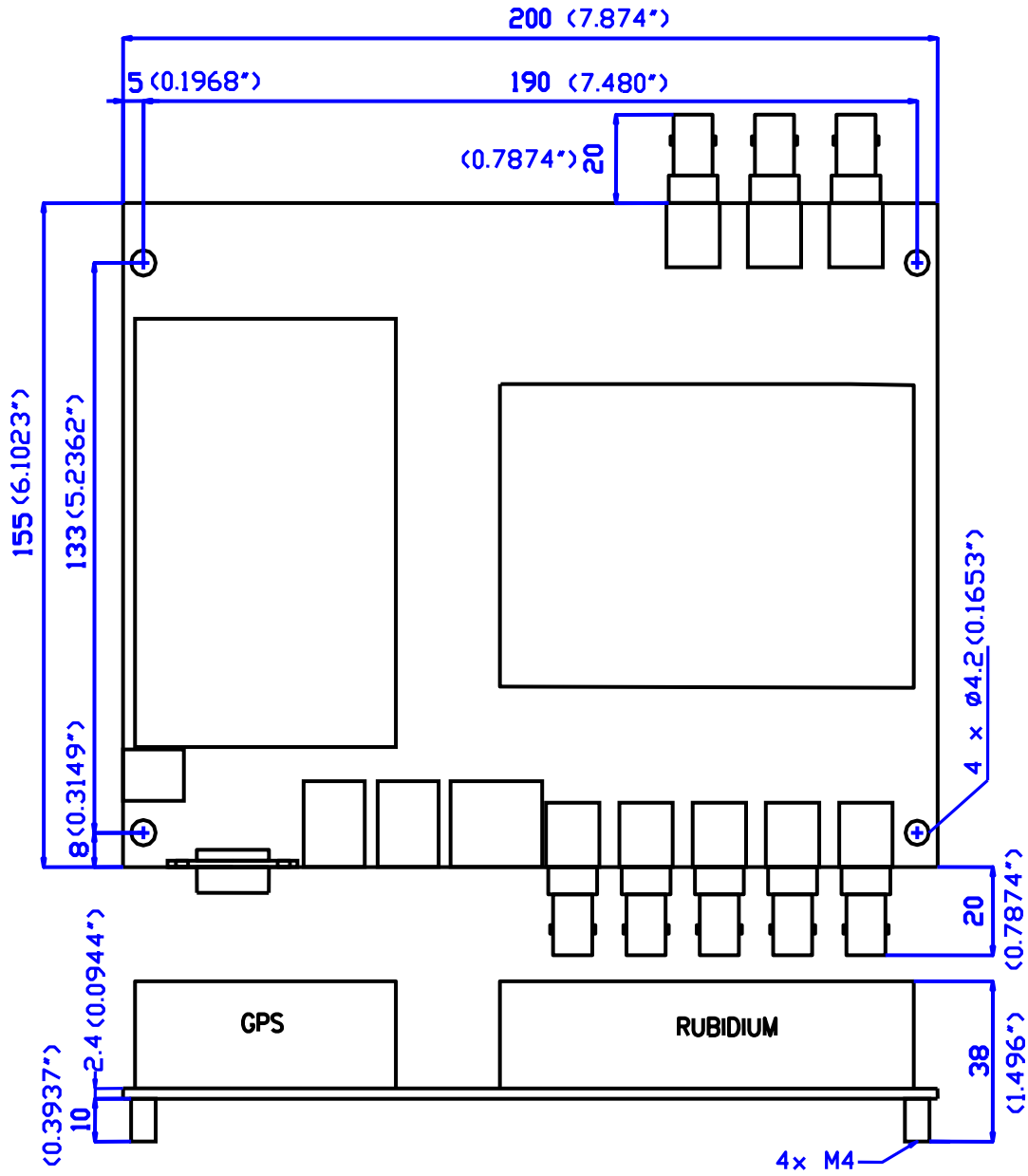

Figure 17

- End of document -